

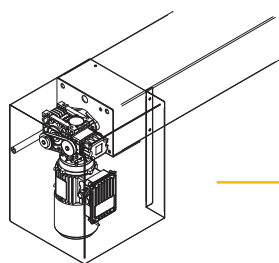

HIGH-SPEED FOLD UP DOORS





UPPER FRAMEWORK

- Upper framework made of steel for a high mechanical strength.
- Pre-assembled components in order to reduce installation time.
- Rolling shaft installed inside the framework and mounted on ball bearings to decrease friction while rotating.
- Separated motor cover in order to access the motor without removing the front cover.
- Laterally mounted geared motor.
- Electrical cables laid inside specific housings for a quick and easy installation.

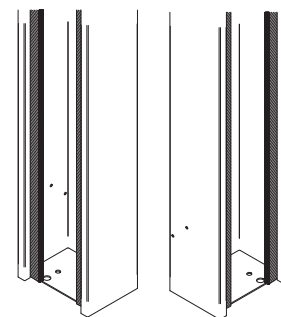

SIDE RUNNERS

- Lateral framework with high mechanical strength due to its strong steel structure.
- Framework composed by a metal sheet profile.
- Brushes made of soft nylon installed laterally in order to reduce friction with flexible curtain.
- Pre-assembled components in order to reduce installation time.

FLEXIBLE CURTAIN

- Made of polyester fabric coated with coloured PVC.
- High tear strength and high traction resistance, in both warp and weft.
- Wide range of available colours (depending on the type of curtain).
- Optional transparent portholes made of clear PVC and realized on Customer's request that improve safety of pedestrians and vehicles passing through the door.
- Optional portholes with mesh.
- Optional portholes with UV screen.
- Wide range of available weights and configuration for special applications.
- Reaction to Fire Classification System: Class B, according to European Standard EN 13501-1.

STANDARD CURTAIN

- Weight in roll 900 g/m².
- Thickness 0.8 mm approx.
- Wide range of available colours.

INSULATED CURTAIN

- Weight in roll 1300 g/m².
- Thickness 4 mm approx.
- Sponge layer on one side for thermal and acoustic insulation.

TRANSPARENT PORTHOLES

- Material PVC.
- Thickness 0.7 mm approx.
- High transparency grade.

	RAL 1015 Beige		RAL 5012 Light blue		RAL 9005 Black
	RAL 1021 Yellow		RAL 5015 Light blue		RAL 9016 White
	RAL 2004 Orange		RAL 6026 Green		
	RAL 3002 Red		RAL 7038 Grey		
	RAL 5002 Blue		RAL 8017 Brown		



LIMIT SWITCH

- Easy to setup and to fine-adjust.
- Available with no. 2 or 4 cams.
- Both N.O. and N.C. contacts on each cam.
- Available with gear ratio of 1/25 or 1/50.
- Produced in Italy.

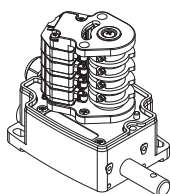

PHOTOCELLS

- Infrared beam technology.
- Emitter and receiver system.
- Easy to install and to replace.
- Produced in Italy.

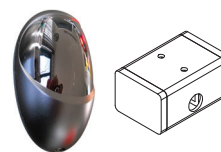

ELECTRICAL DEVICES

- Industrial control panels for any application.
- Wide range of available opening commands.
- Special devices made on Customers' needs.



SPECIFICATIONS

Supply voltage	400 Vac ⁽¹⁾
Supply type	Three-phases ⁽¹⁾
Supply frequency	50 Hz
Control panel	Automatic
Motor type	Asynchronous
Motor duty cycle	S1 100 %
Gearbox type	Worm
Wind load resistance	Up to class 5

(1) Supply 230 Vac single-phase or three-phases on request

Maximum width	15 m
Maximum height	10 m
Maximum area	100 m ²
Opening speed	Up to 0.8 m/s or more
Limit switch	Mechanical
Panel type	Flexible
Framework	Metallic
Cycles ⁽²⁾	1.000.000

(2) flexible panel and wear material excluded

SAFETY EDGE

- Electrically conductive rubber.
- Base aluminium profile.
- High sensitivity to object detection.
- High reliability without maintenance.
- Fully complies with EU rules.
- Produced in Germany.



WIRELESS SYSTEM

- Safety edge wireless connection.
- Operative frequency of 868 MHz.
- Supplied with batteries that last 2 years.
- Fully complies with EU rules.
- Produced in Spain.



GEARED MOTOR

- Three-phases asynchronous motor.
- Standardized dimensions and power.
- Heavy duty cycle S1 - 100%.
- Aluminium case with cooling fins.
- Ventilation fan with radial blades.
- Brake with high blocking torque.
- Protection degree: IP 54 / optional IP 55.
- Worm geared system.
- Lubricated for life.
- Produced in Italy.

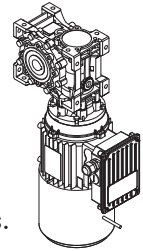

DIMENSIONS - TYPE 1

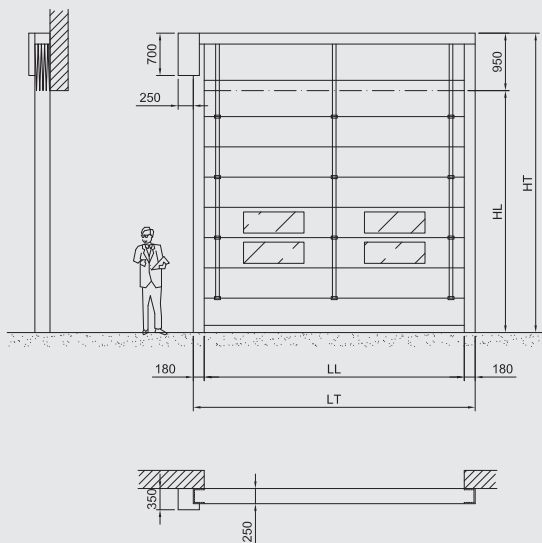

DIMENSIONS - TYPE 2

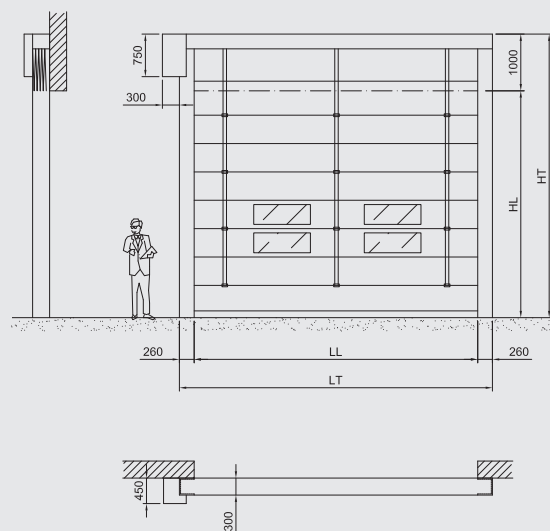

DIMENSIONS - TYPE 3

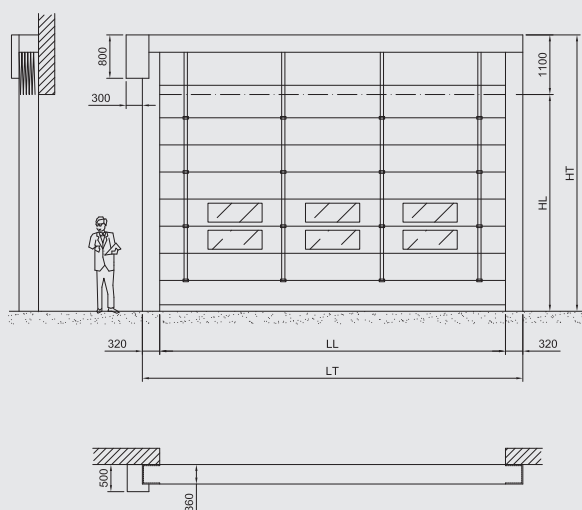

EUROPEAN STANDARD COMPLIANCE

- Fully complies with rule EN 13241-1.
- "Standard for industrial, commercial and garage, doors and gates".
- Maximum safety to avoid any injury to workers while opening and closing.
- Door submitted to a strict "Initial Type Test" carried out by the manufacturer under the control of an organism registered with the Italian Ministry of Economic Development.
- CE declaration and CE marking.

